

enmiklavcjoy

Loka turizem

Turistična točka Škofje Loke in Poljanske doline — koncept

stmiklavcudio | Podlubnik 314 | 4220 Škofja Loka | Slovenia|www.miklavc.si | september 2016

Inspiracija | izhodišča

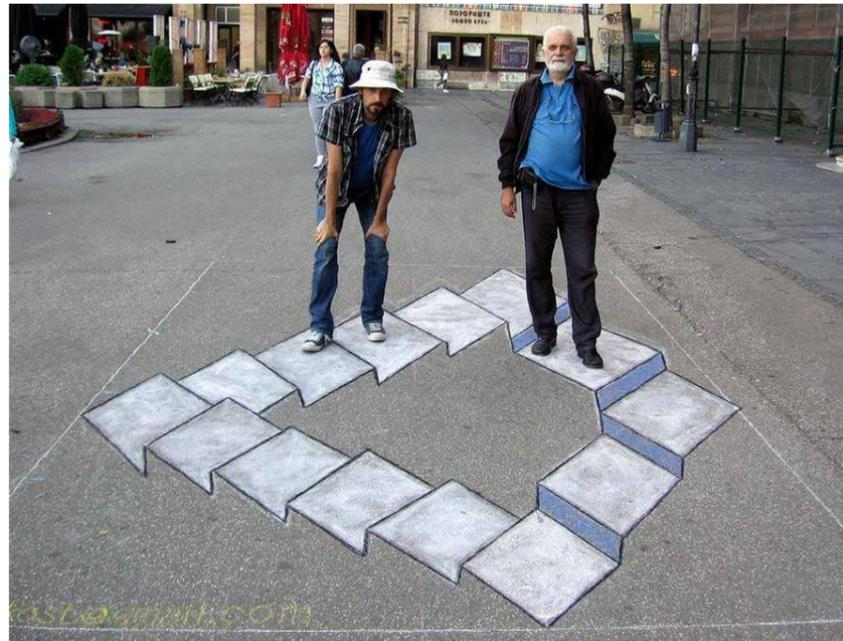
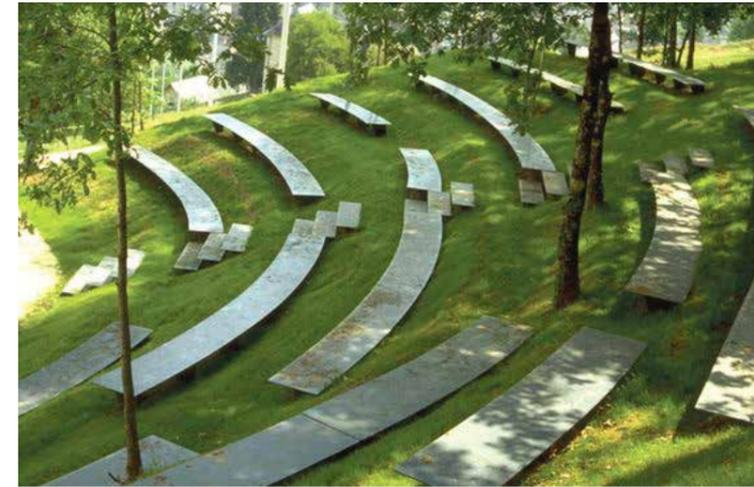
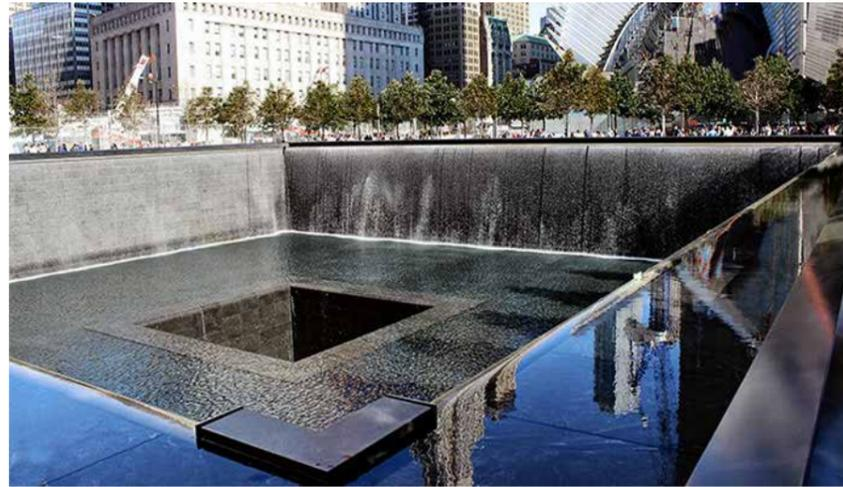
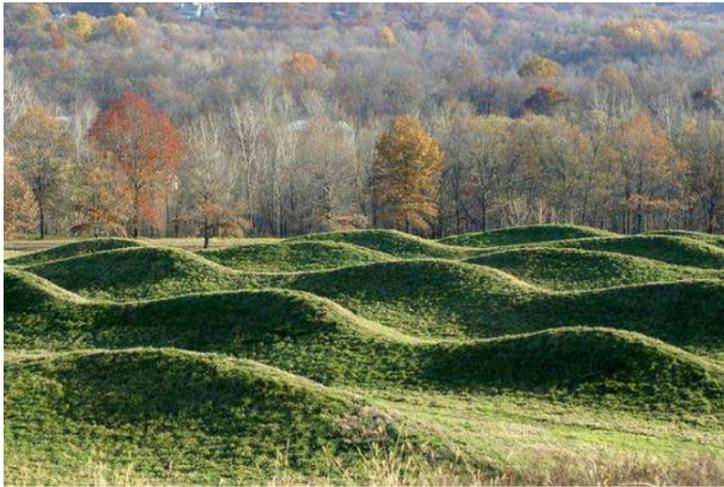

Turistična točka Škofja Loka

 ŠKOFJA
LOKA

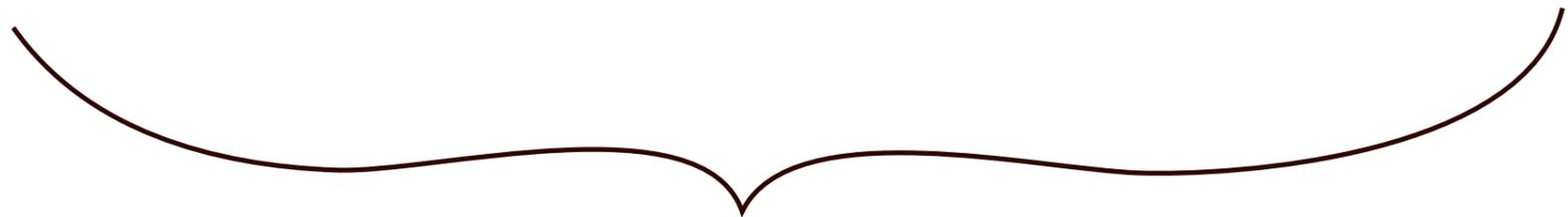
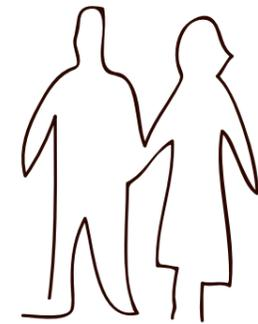

Turistična točka Poljanska dolina

fotograf

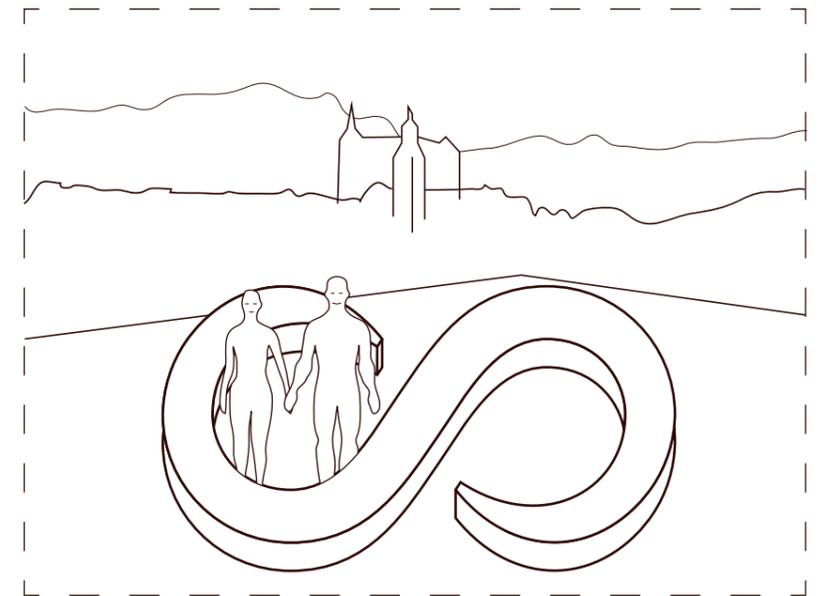
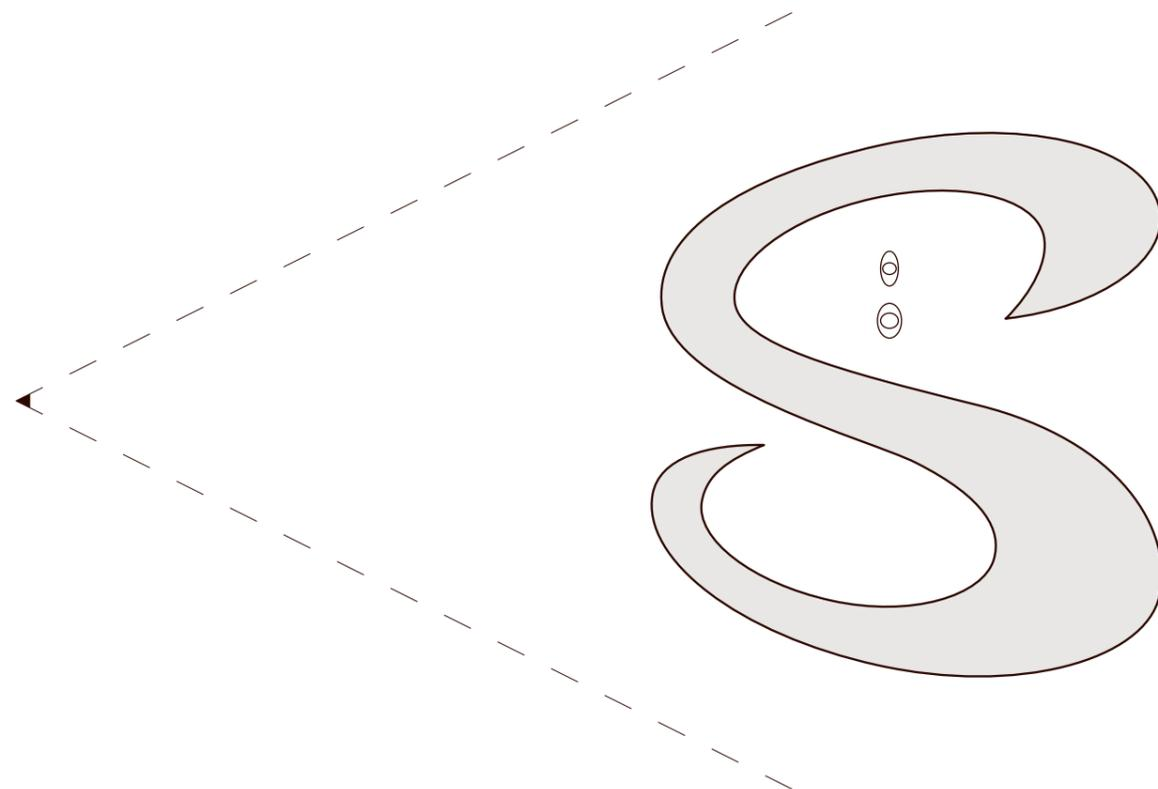

Turistična točka Škofja Loka

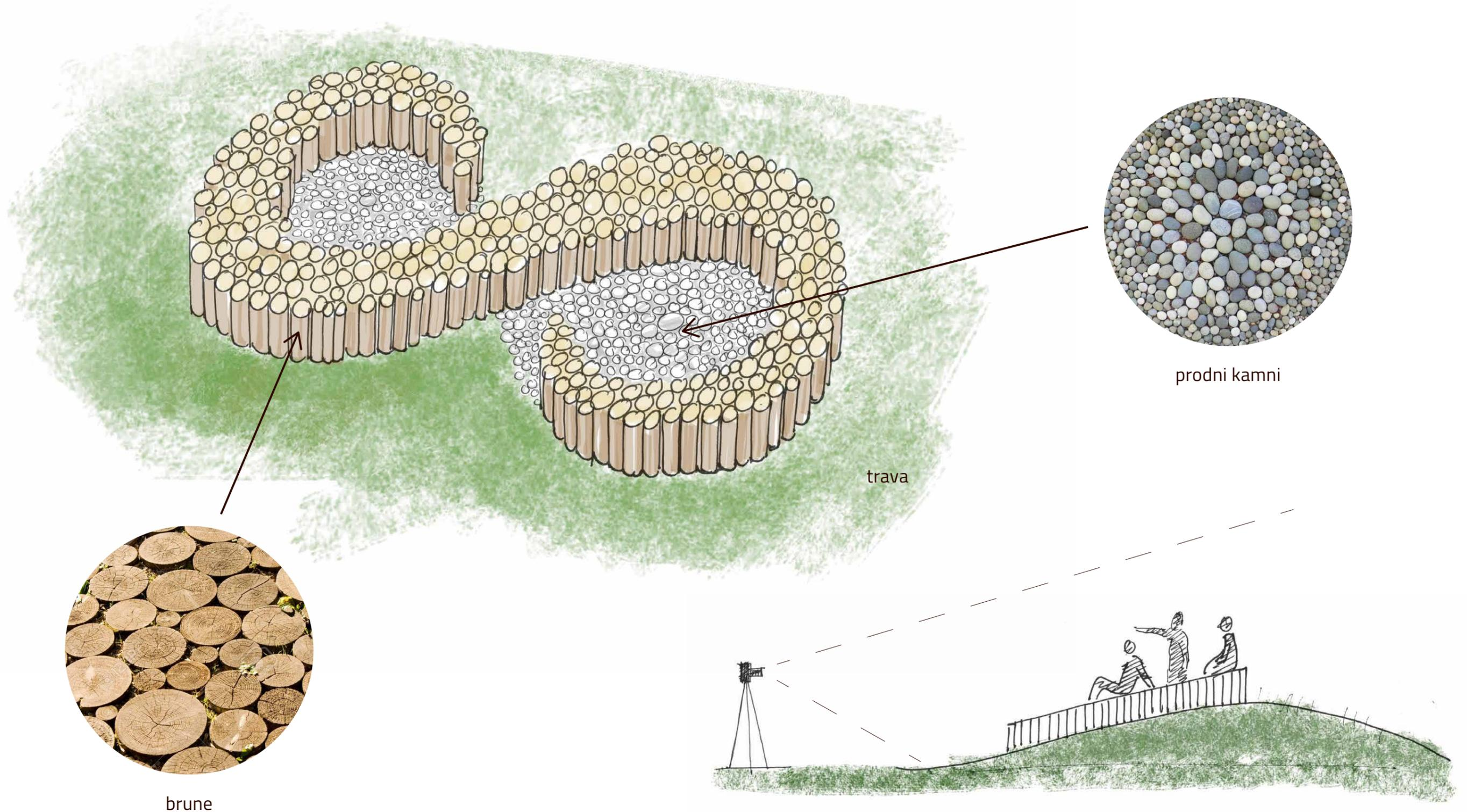

Turistična točka Škofja Loka



Turistična točka Škofja Loka



Turistična točka Škofja Loka



Turistična točka Poljanska dolina

Poljanska  dolina
dežela pod Blegošem

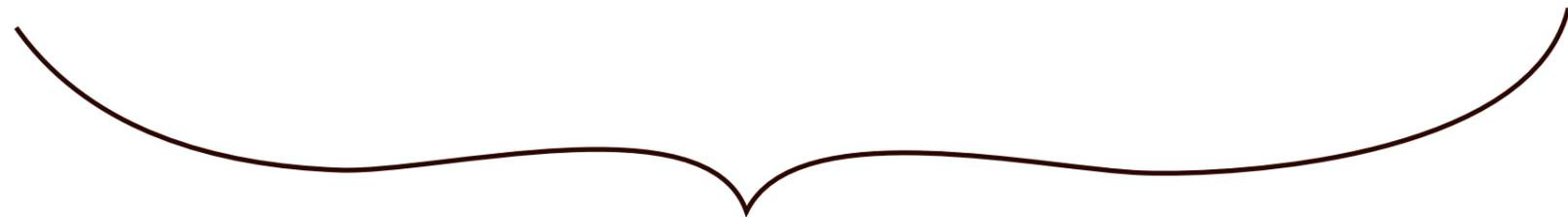
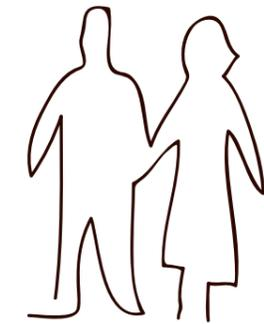

Turistična točka Poljanska dolina

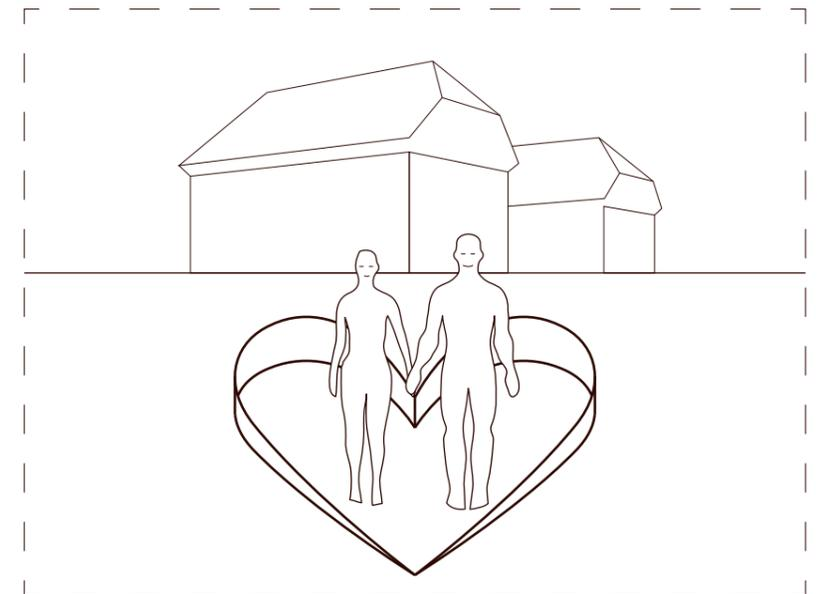
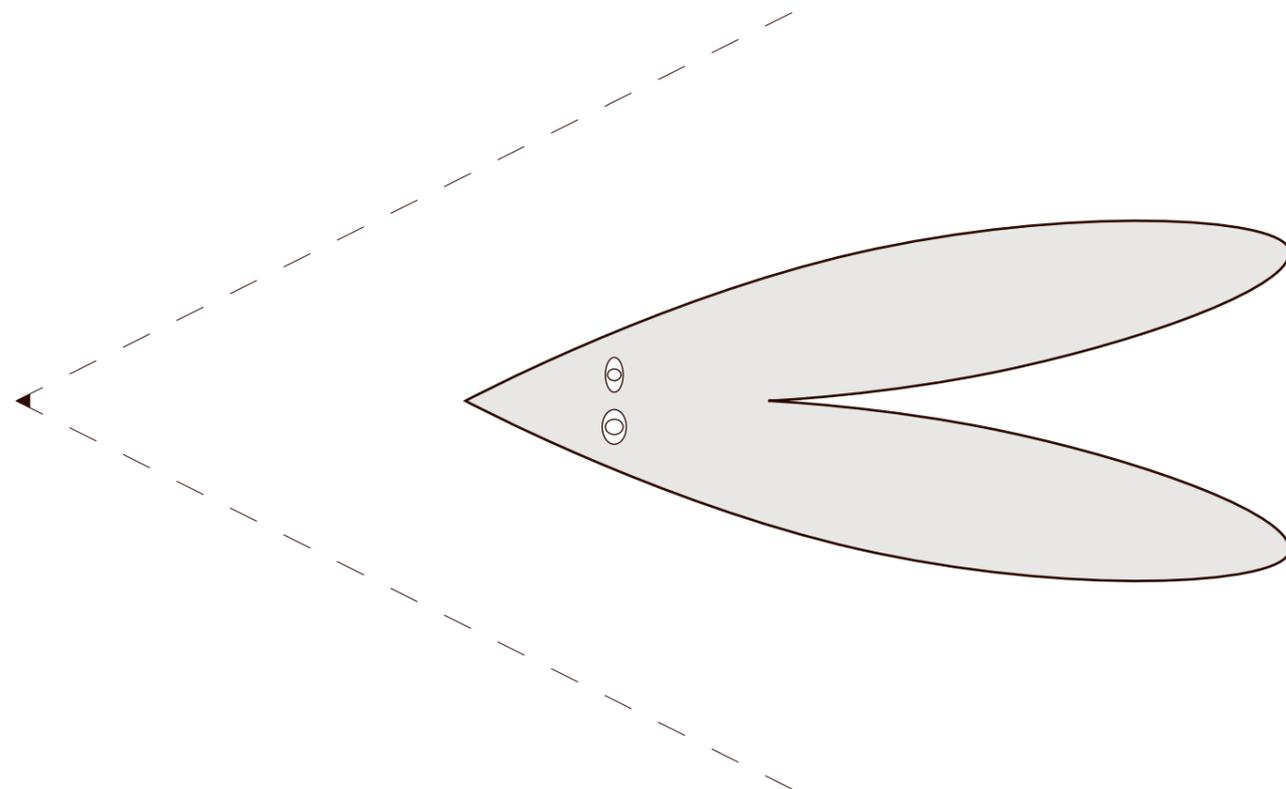
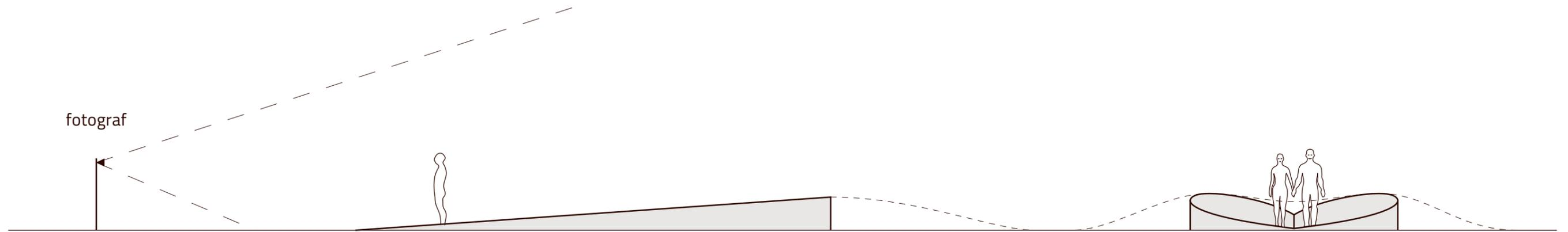

Turistična točka Poljanska dolina

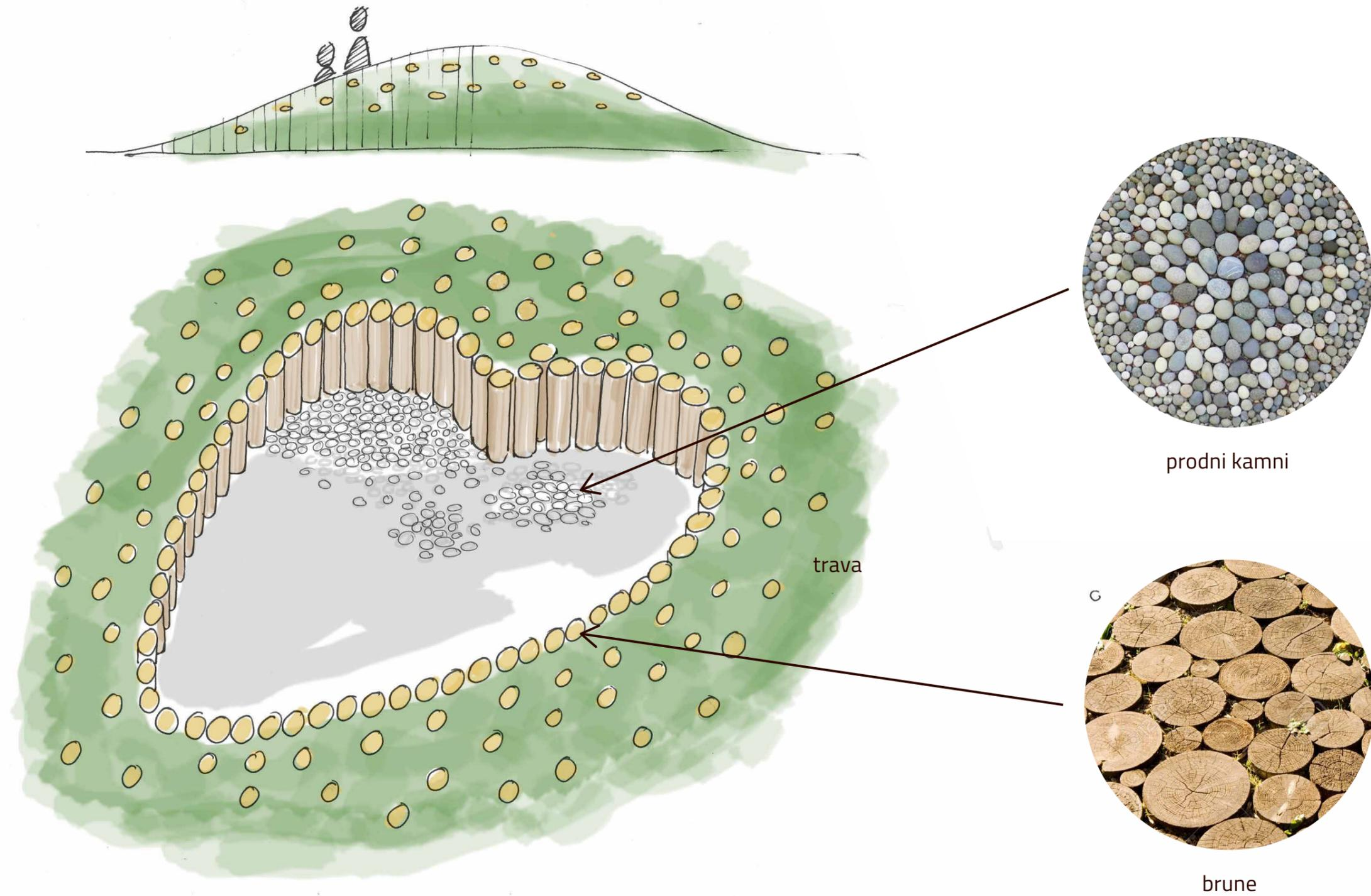

Turistična točka Poljanska dolina

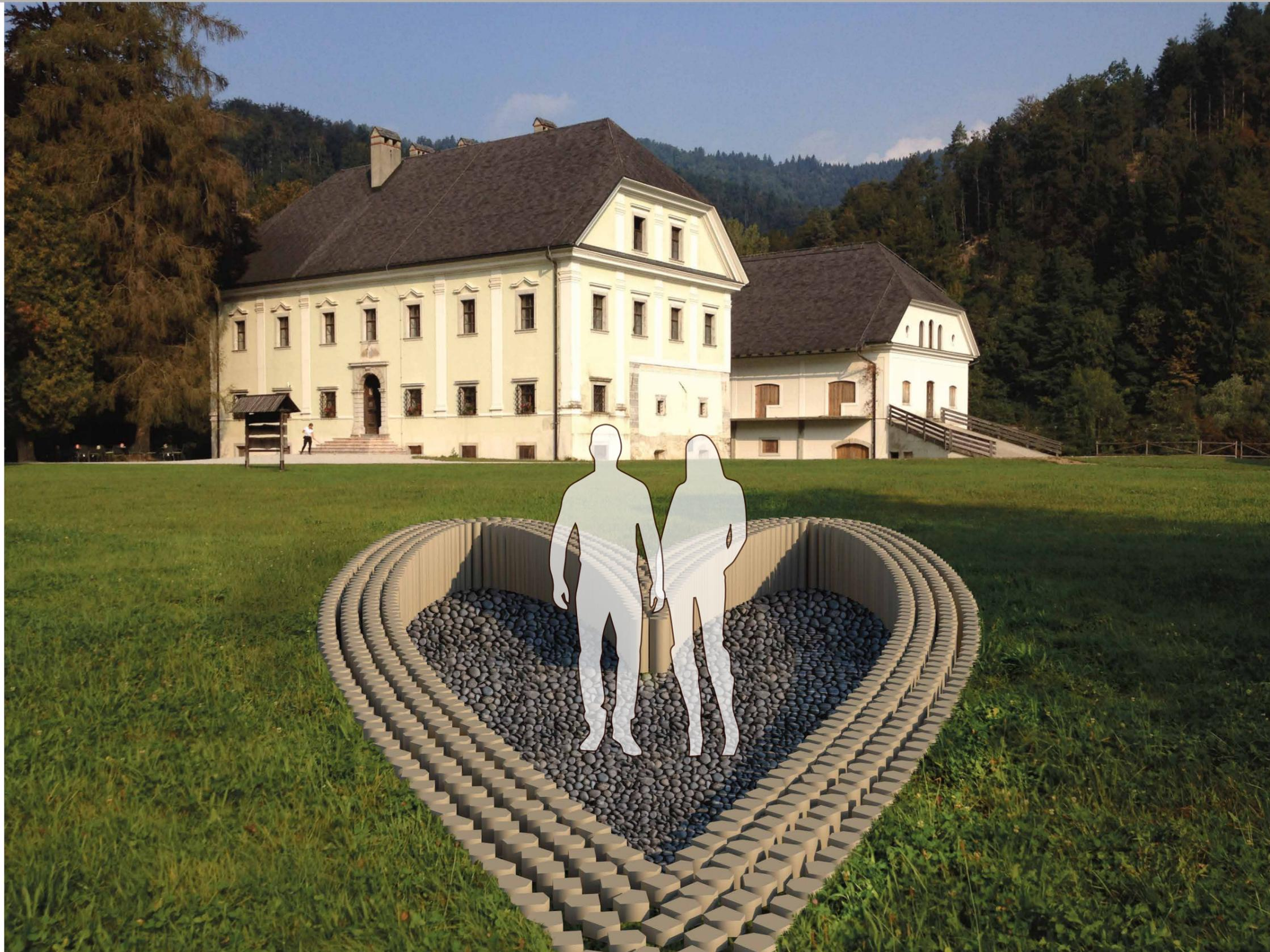

Turistična točka Poljanska dolina



Turistična točka Poljanska dolina



Turistična točka Poljanska dolina



Turistična točka Poljanska dolina

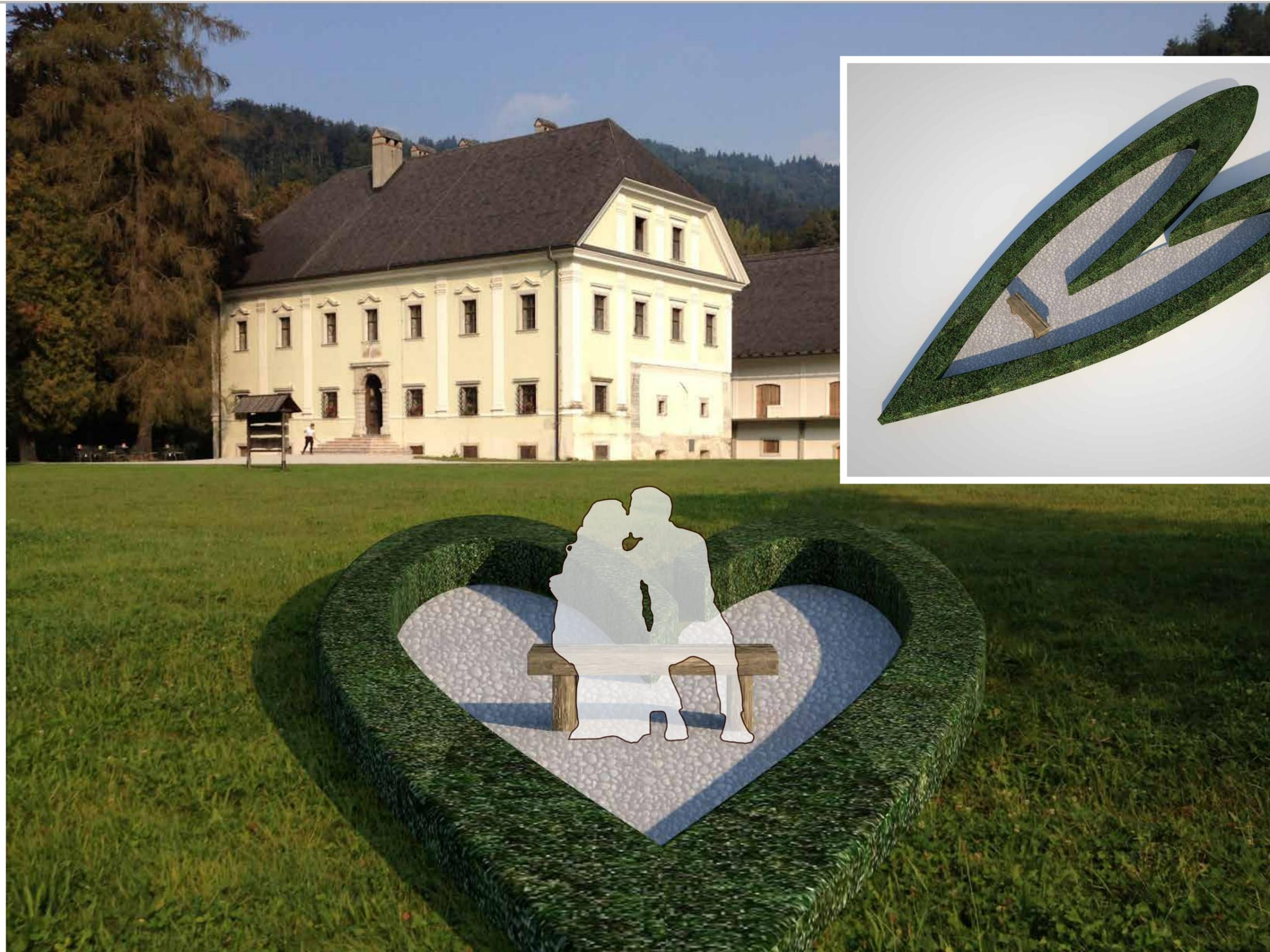

thank**miklavc**you

stmiklavcudio | Podlubnik 314 | 4220 Škofja Loka | Slovenia|www.miklavc.si | september 2016